

Euro Systems®
Healthcare Curtain

Track System - 4100 and Fabric

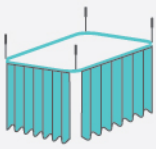



Curtain Track System 4100

Conforming to HTM66, 4100 series offers a comprehensive range of accessories to suit all fixing possibilities. Elegant in design and function 4100 is suitable for use with up-lighters for improved ambient hospital ward lighting. Synthetic wall and ceiling fitting allow the track to comply with the European NEN-3134 standard for special care rooms requiring anti-static facility.

Standard Colours: White RAL 9010, Natural.

Specification

This system can also be mounted with anti-ligature load release components, to provide a controlled system collapse.

NEN-3134: Isolated fixing in S3 (anti-static) rooms. Ceiling fixing with suspension hung (using synthetic ceiling stud), wall fixing with plexiglass wall bracket and synthetic wall support. An earth cable needs to be connected.

Light	Medium	Heavy (curtains)
240*)	180*)	120 cm

*) Please take into account the the lateral deflection within the rail. This effect can be reduced by using a V-hanger or strut-hanger with fixing plate.

Bending

Minimum radius 20 cm

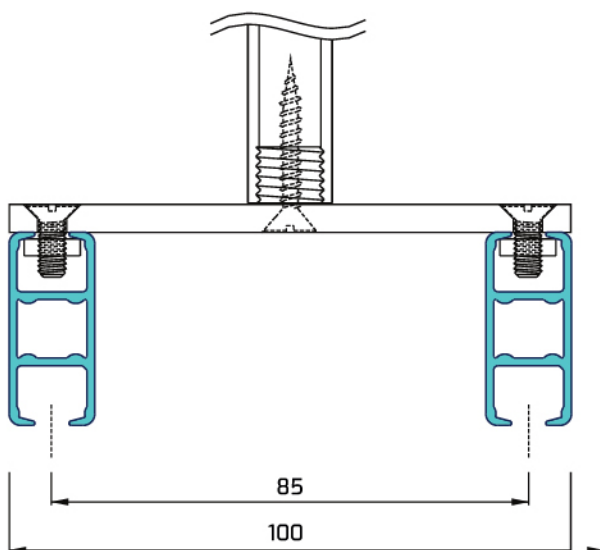

Parallel rail fixing with bridging plate

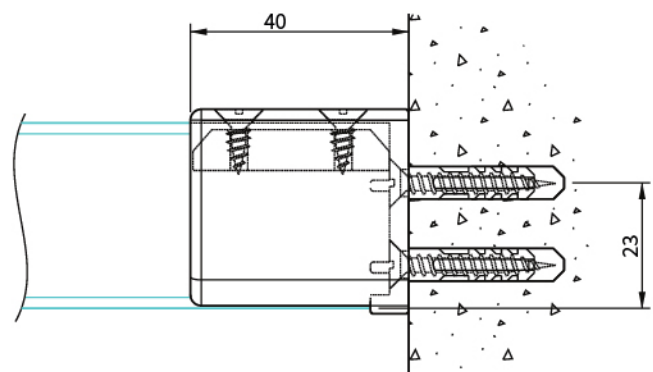

Wall fixing with bracket

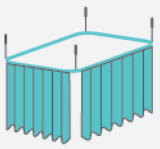

Specification

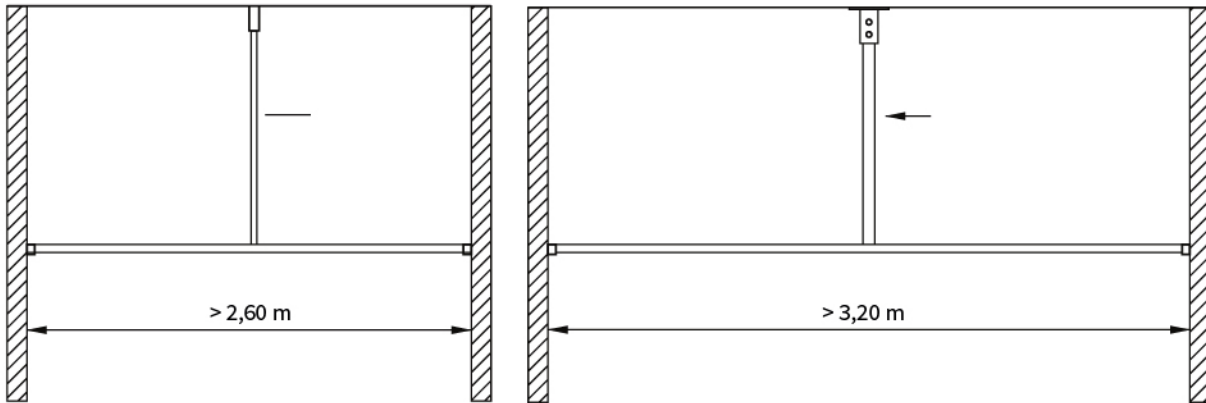

This picture shows when a 'strut-hanger' or V-hanger is used and when a vertical suspension hanger is sufficient.

Bracket fixing guide

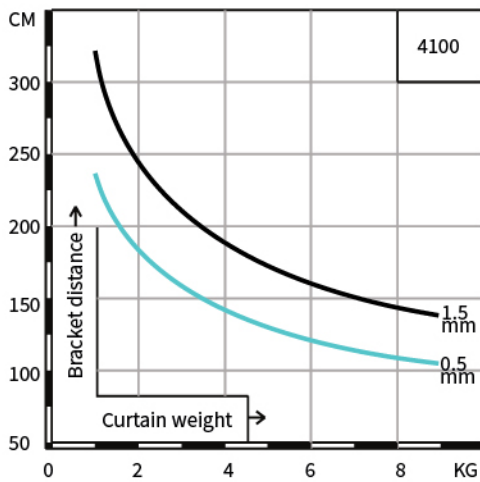

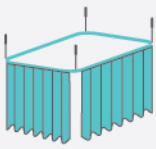

Installation (Continuation)

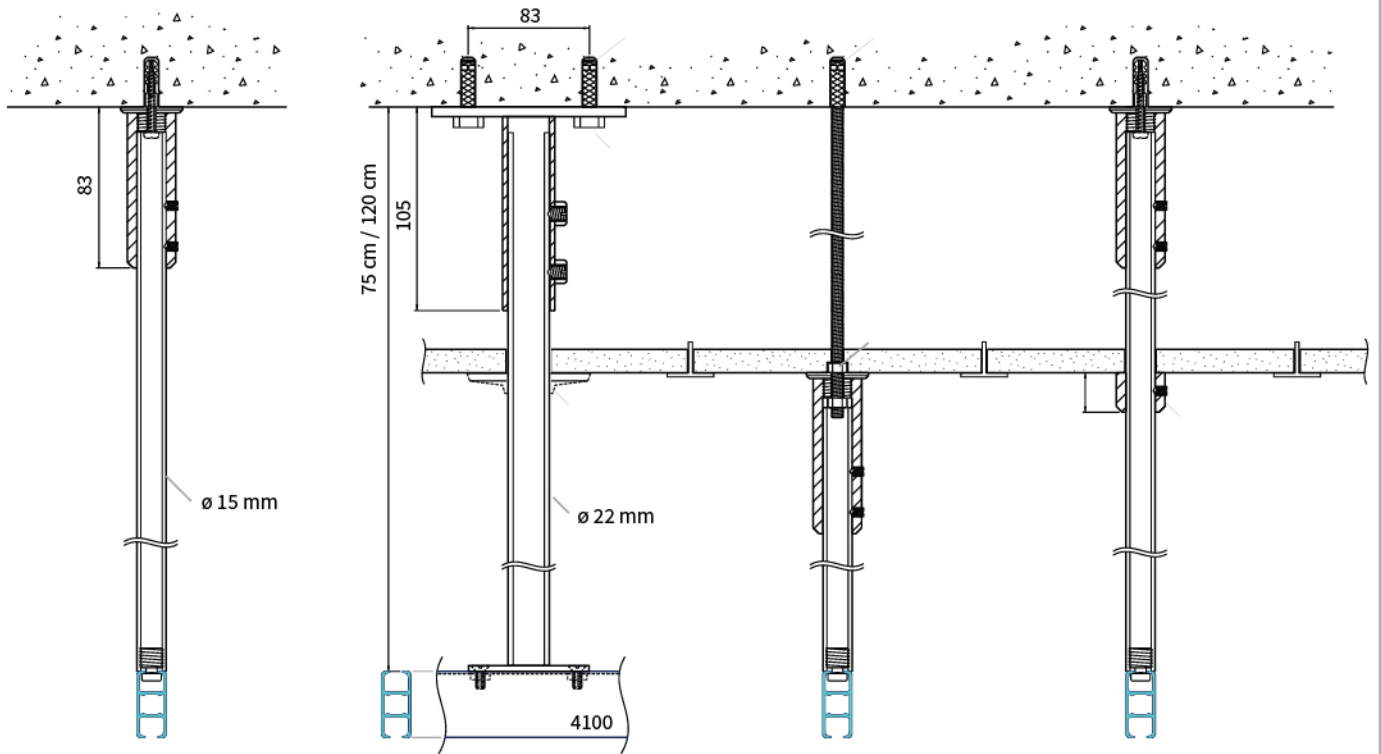

Ceiling fixing with suspension hanger

Ceiling fixing with strut hanger through suspended ceiling tiles

Ceiling fixing with suspension hanger and M6 threaded rod through suspended ceiling tiles

Ceiling fixing with suspension hanger through suspended ceiling tiles with dummy ceiling support (or ceiling rose)

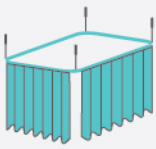

Euro Systems®

Healthcare Curtain

Track System - 4100 and Fabric

Installation (Continuation)

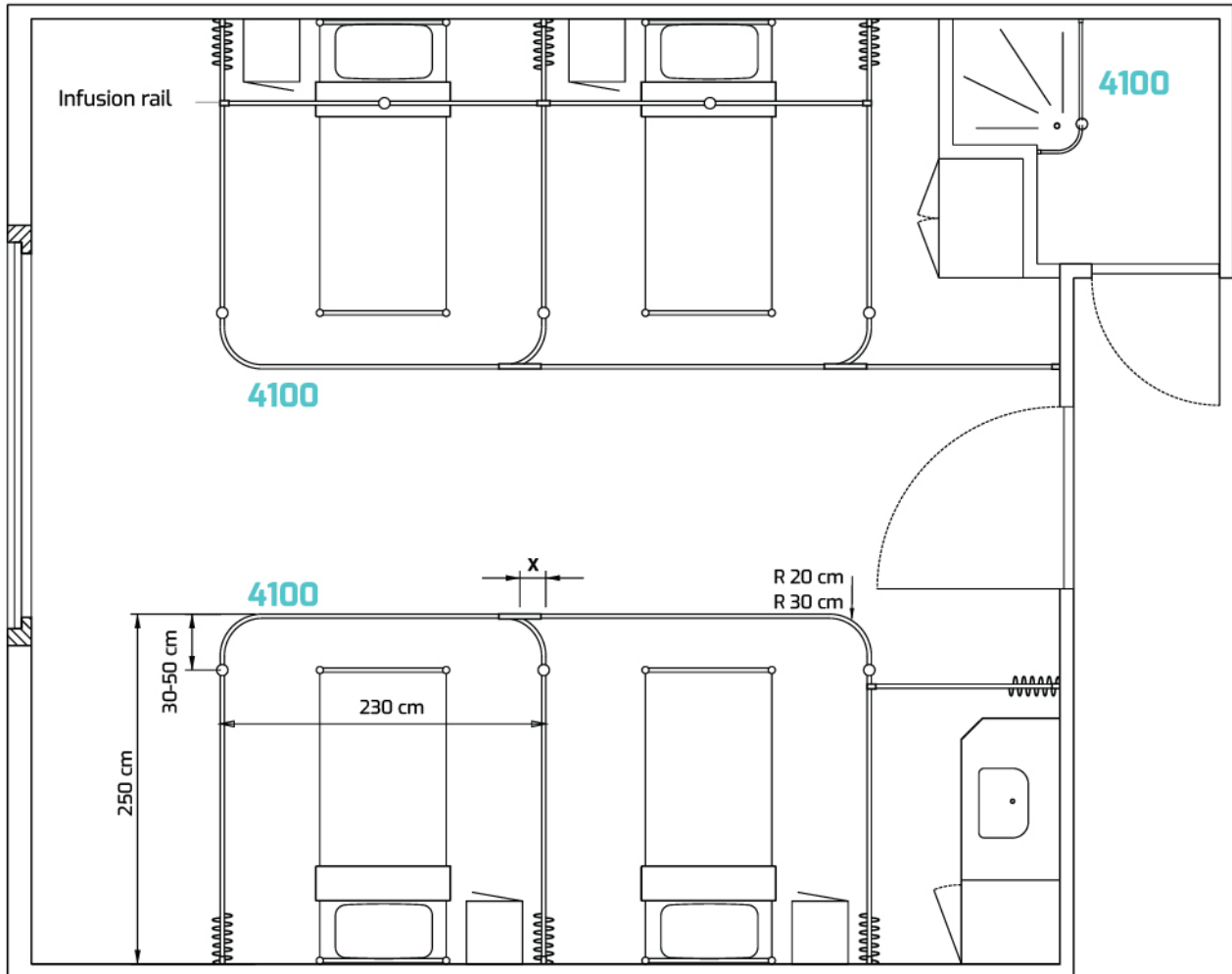

x = Connecting bridge over-sail

25 cm at R30
13.5 cm at R20

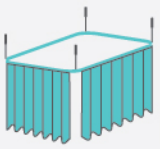

Euro Systems®

Healthcare Curtain

Track System - 4100 and Fabric

PETTERN: ACER

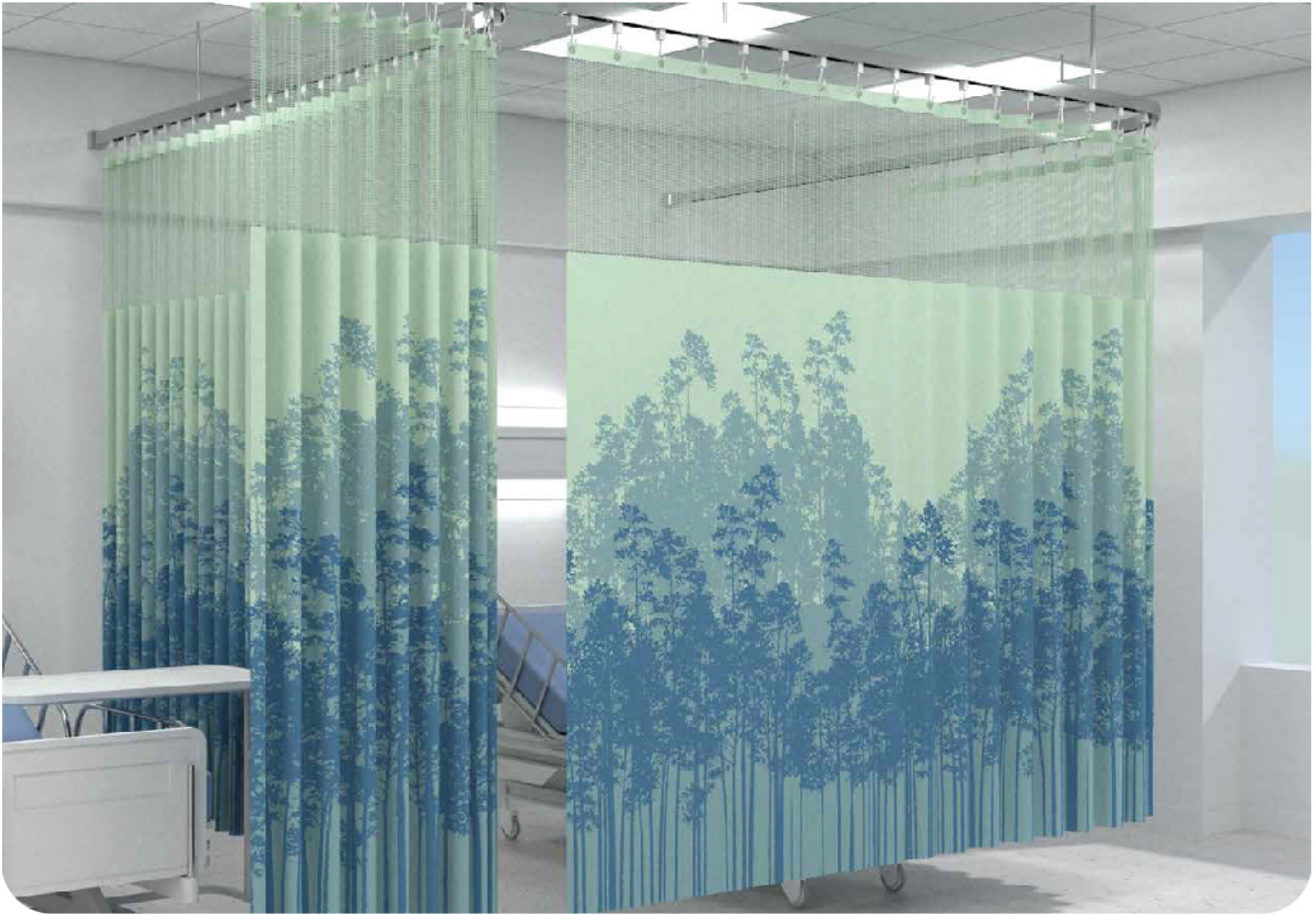

Colors



BIRDS EYE



BROADLEAF



CLEARING

Description: 102" wide dual sided printed including 21" of integral mesh.

Maximum Railroaded Seamless Curtain Height: 98" including integral mesh.

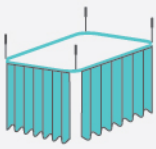

Euro Systems®

Healthcare Curtain

Track System - 4100 and Fabric

PETTERN: AFFINITY

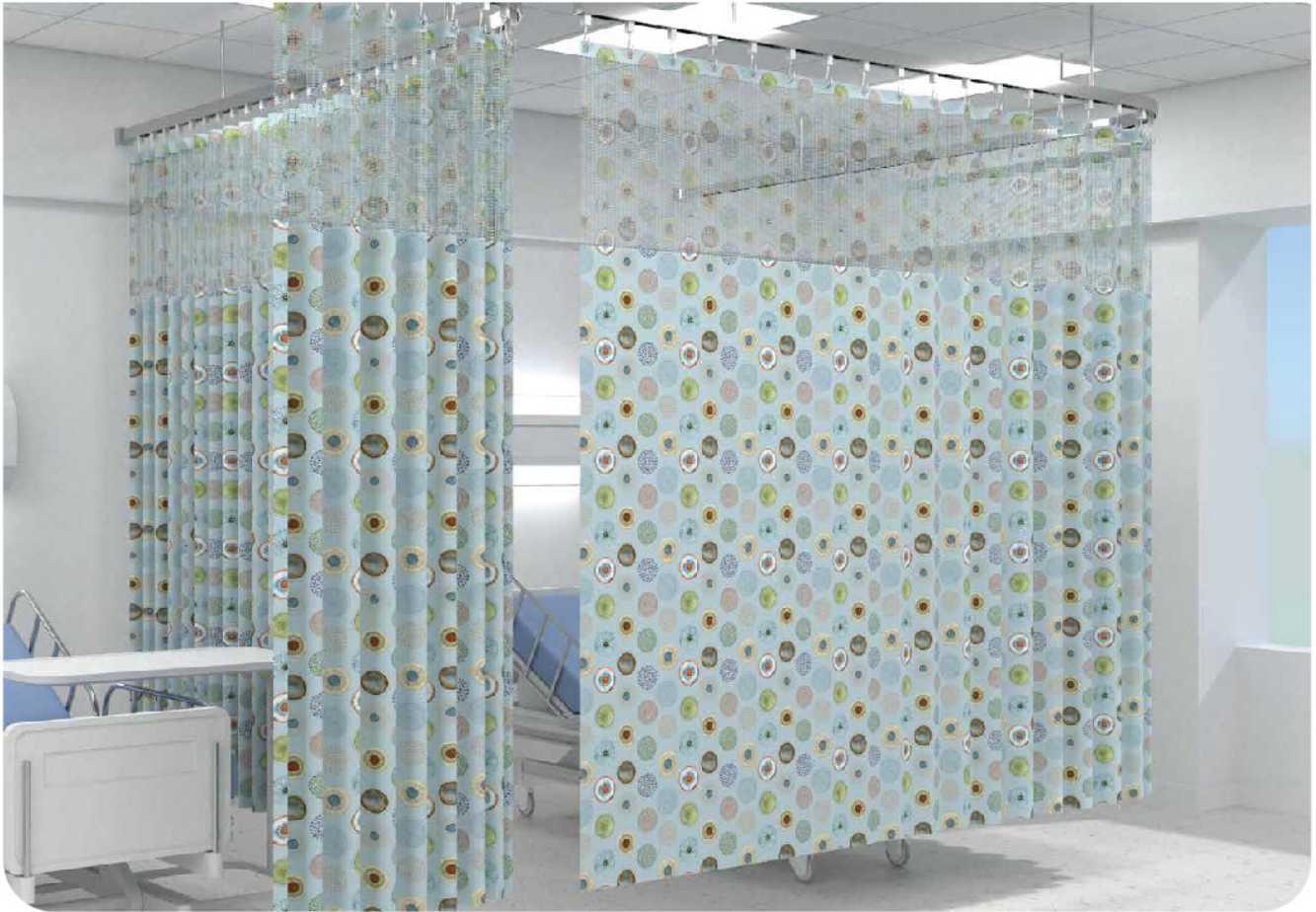

Colors



BUFF MULTI



PEARL GREY



SPA BLUE

Description: 102" wide dual sided printed including 21" of integral mesh.

Maximum Railroaded Seamless Curtain Height: 98" including integral mesh.

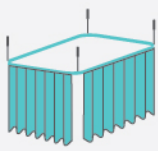

Euro Systems®

Healthcare Curtain

Track System - 4100 and Fabric

PETTERN: CROSSHATCH

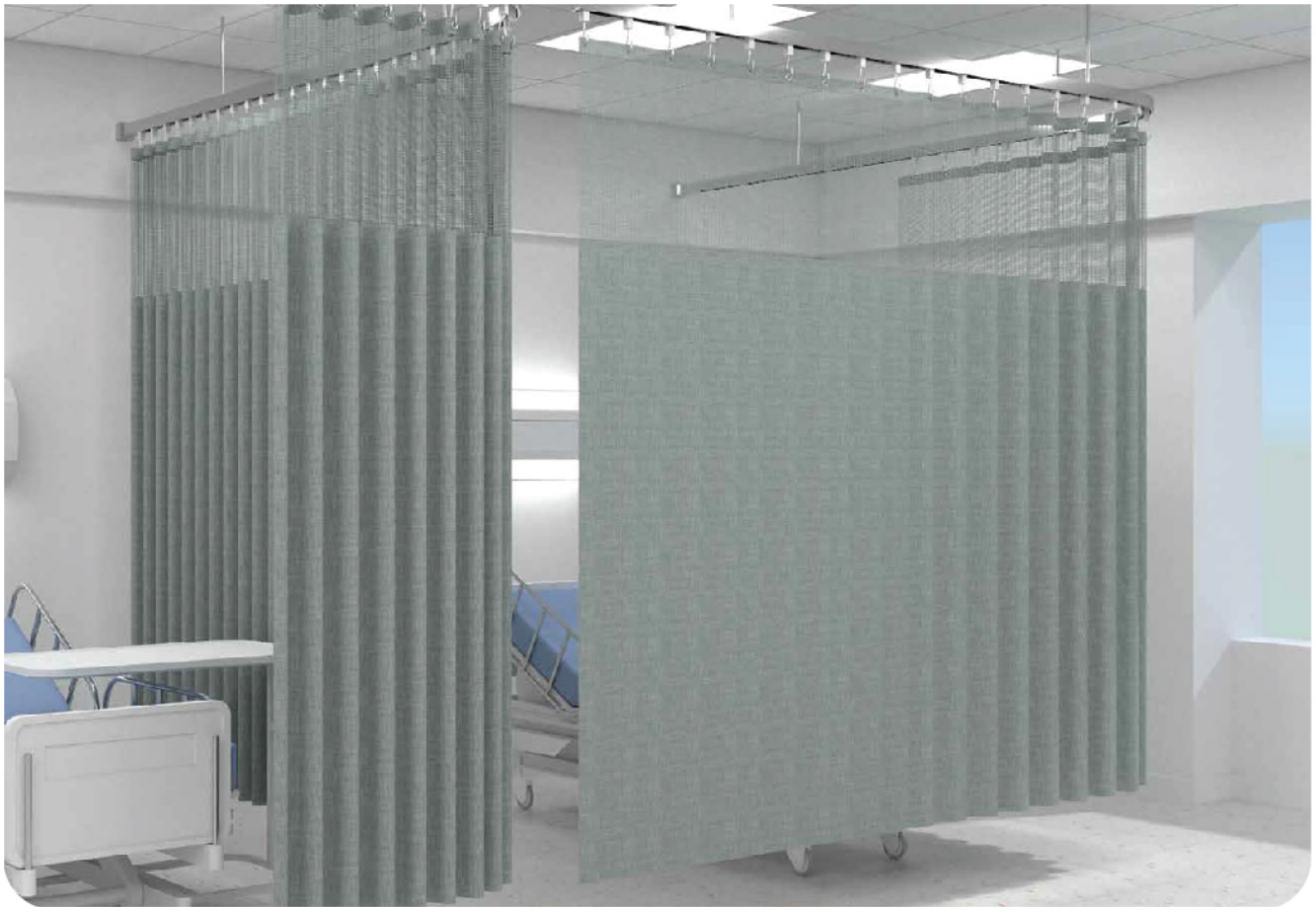

Colors



COPPER



COOL GREY



TAUPE

Description: 102" wide dual sided printed including 21" of integral mesh.

Maximum Railroaded Seamless Curtain Height: 98" including integral mesh.

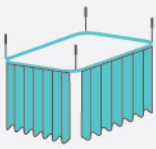

Euro Systems®

Healthcare Curtain

Track System - 4100 and Fabric

PETTERN: CRYSTAL



Colors



AQUAMARINE



CHRYSOLITE



PADPARA

Description: 102" wide dual sided printed including 21" of integral mesh.

Maximum Railroaded Seamless Curtain Height: 98" including integral mesh.

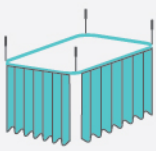

Euro Systems®

Healthcare Curtain

Track System - 4100 and Fabric

PETTERN: ELEMENTS

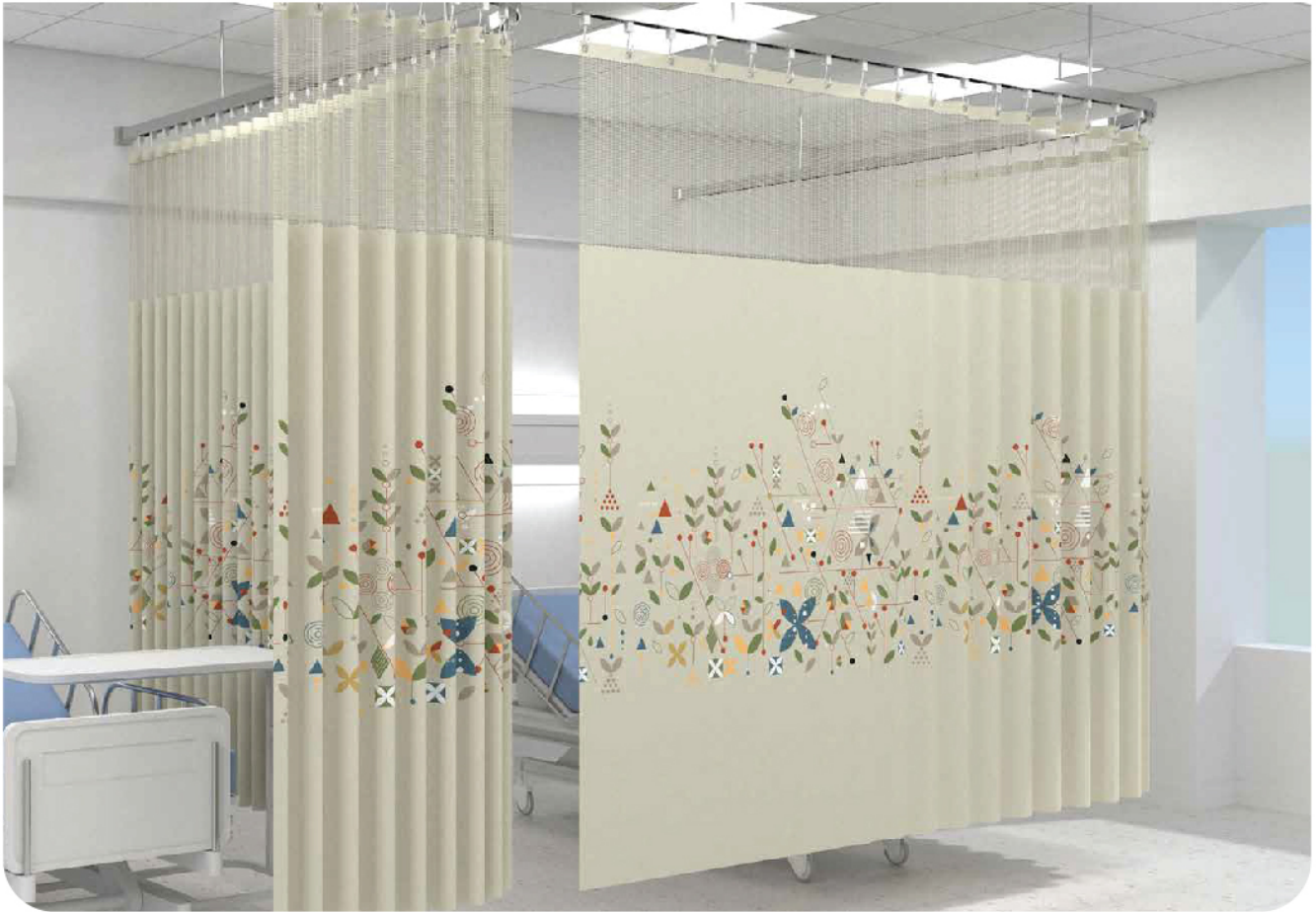

Colors



MULTI

Description: 102" wide dual sided printed including 21" of integral mesh.

Maximum Railroaded Seamless Curtain Height: 98" including integral mesh.

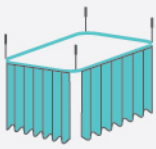

Euro Systems®

Healthcare Curtain

Track System - 4100 and Fabric

PETTERN: GRASSFIELDS

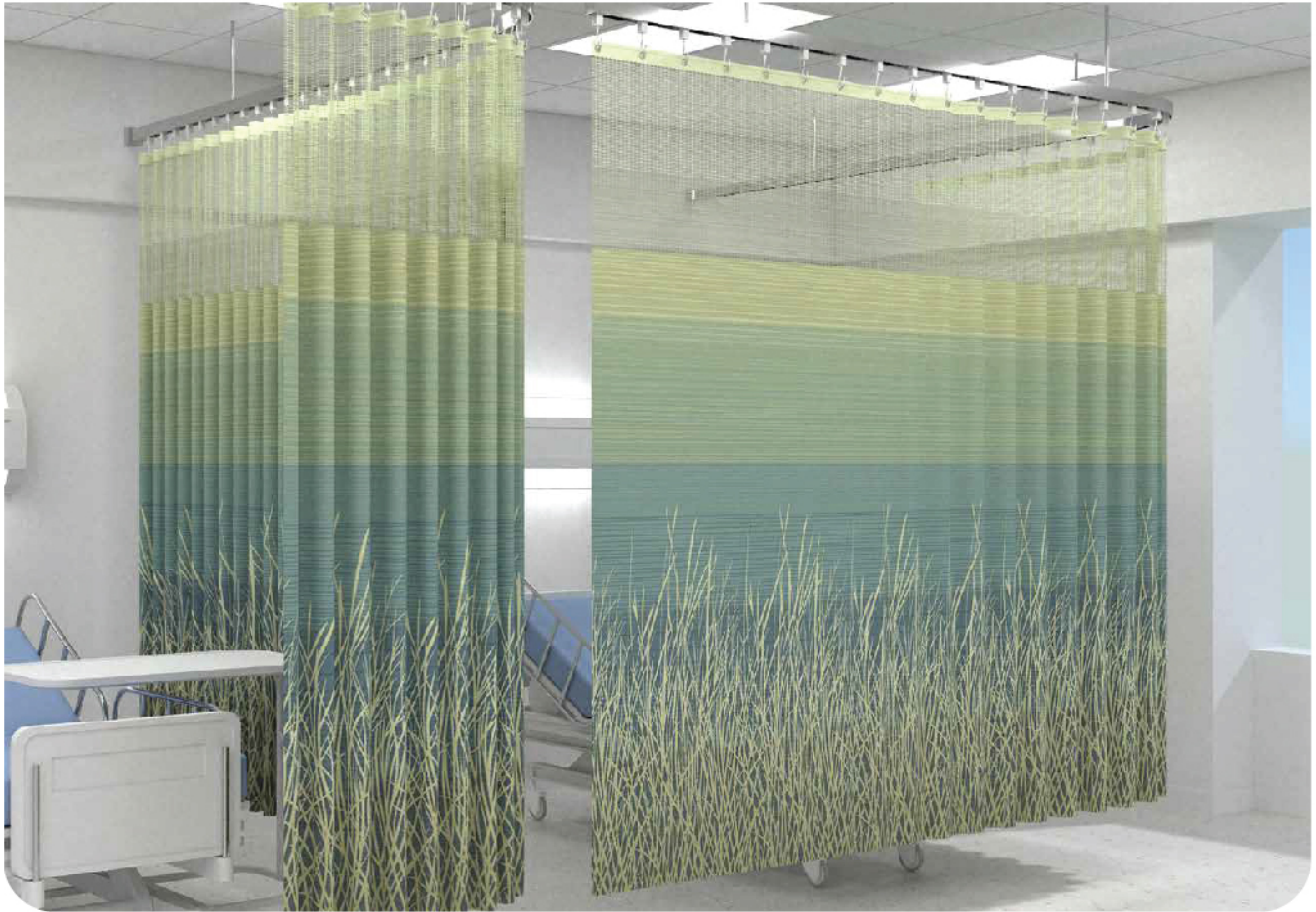

Colors



SUMMER



AUTUMN



SPRING

Description: 102" wide dual sided printed including 21" of integral mesh.

Maximum Railroaded Seamless Curtain Height: 98" including integral mesh.

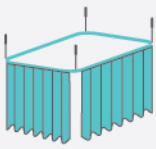

Euro Systems®

Healthcare Curtain

Track System - 4100 and Fabric

PETTERN: HENRI



Colors



PROMENADE



CHAUSÉE



MANTEAU

Description: 102" wide dual sided printed including 21" of integral mesh.

Maximum Railroaded Seamless Curtain Height: 98" including integral mesh.

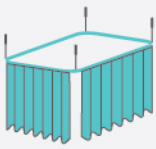

Euro Systems®

Healthcare Curtain

Track System - 4100 and Fabric

PETTERN: MAIOLICA

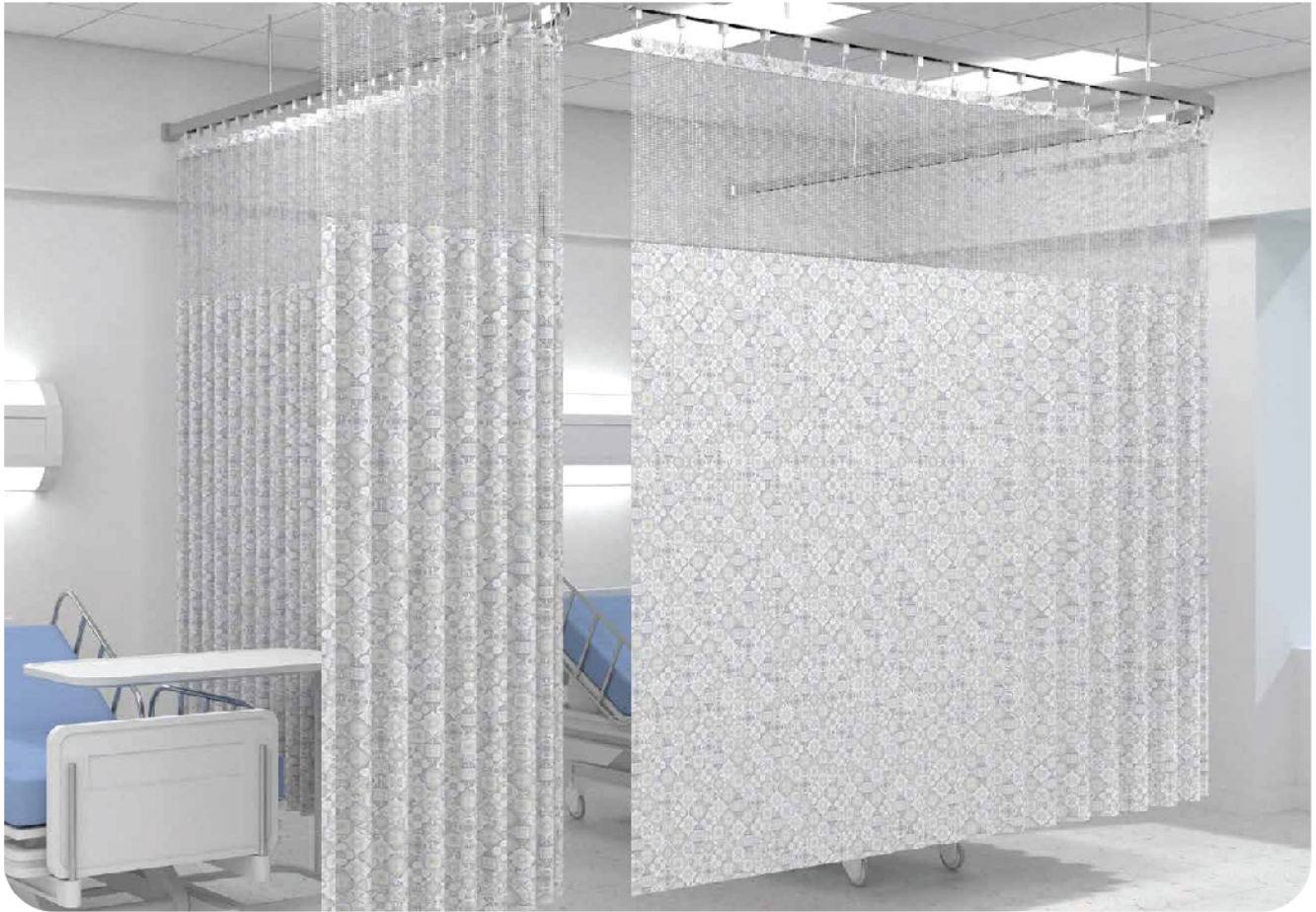

Colors



TOPSAIL



MARBLE



DAWN

Description: 102" wide dual sided printed including 21" of integral mesh.

Maximum Railroaded Seamless Curtain Height: 98" including integral mesh.

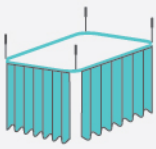

Euro Systems®

Healthcare Curtain

Track System - 4100 and Fabric

PETTERN: MAYCROFT



Colors



STONE



MOSS



DAWN

Description: 102" wide dual sided printed including 21" of integral mesh.

Maximum Railroaded Seamless Curtain Height: 98" including integral mesh.

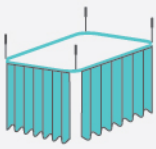

Euro Systems®

Healthcare Curtain

Track System - 4100 and Fabric

PATTERN: PLAID



Colors



CASCADE



THRESHOLD



PATIENCE

Description: 102" wide dual sided printed including 21" of integral mesh.

Maximum Railroaded Seamless Curtain Height: 98" including integral mesh.

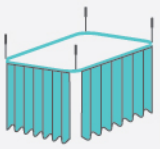

Euro Systems®

Healthcare Curtain

Track System - 4100 and Fabric

PETTERN: SOPHIA STRIPE



Colors

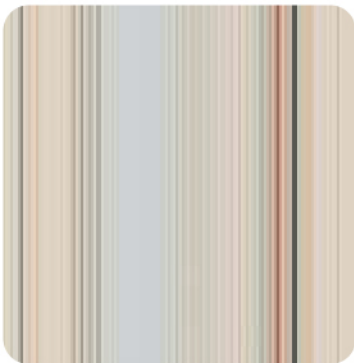

CASCADE

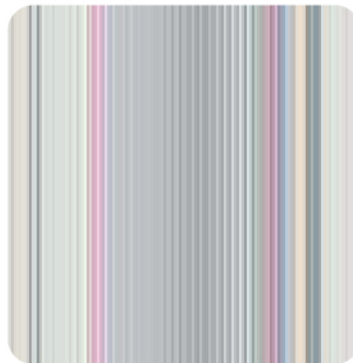

THRESHOLD

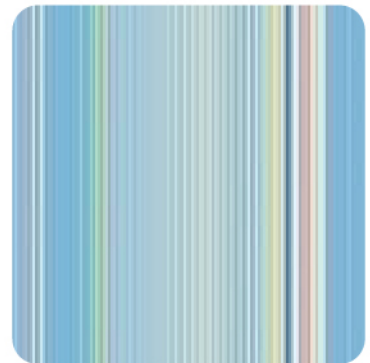

PATIENCE

Description: 102" wide dual sided printed including 21" of integral mesh.

Maximum Railroaded Seamless Curtain Height: 98" including integral mesh.

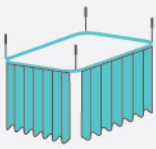

Euro Systems®

Healthcare Curtain

Track System - 4100 and Fabric

PETTERN: STRATA

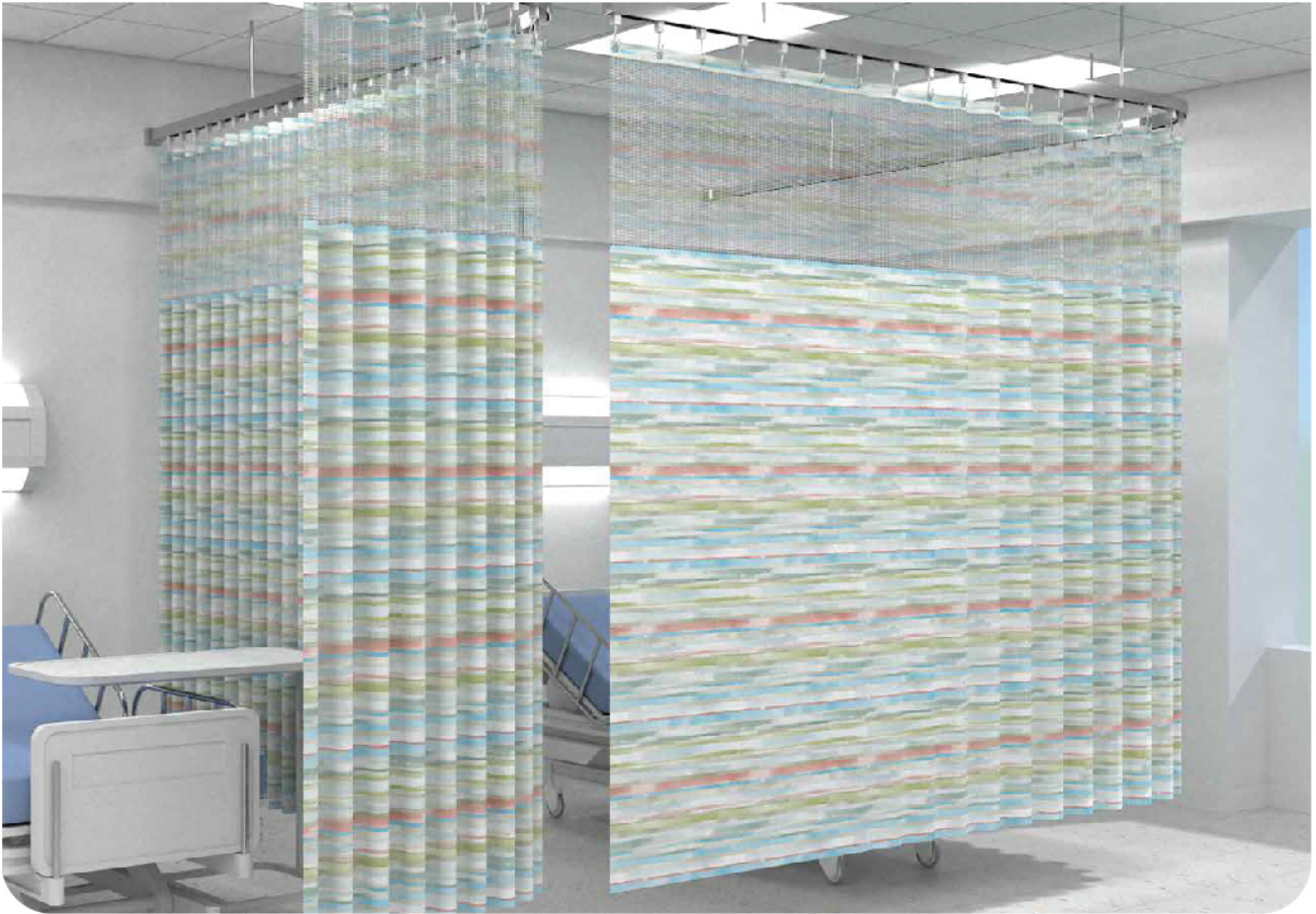

Colors



CASCADE

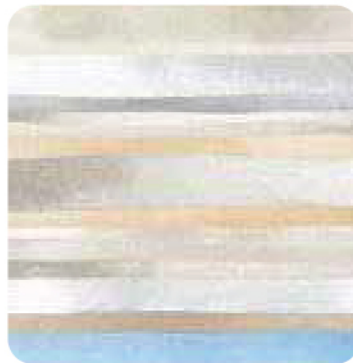

THRESHOLD



PATIENCE

Description: 102" wide dual sided printed including 21" of integral mesh.

Maximum Railroaded Seamless Curtain Height: 98" including integral mesh.

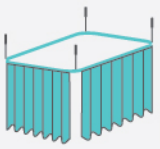

Euro Systems®

Healthcare Curtain

Track System - 4100 and Fabric

PATTERN: TYBEE

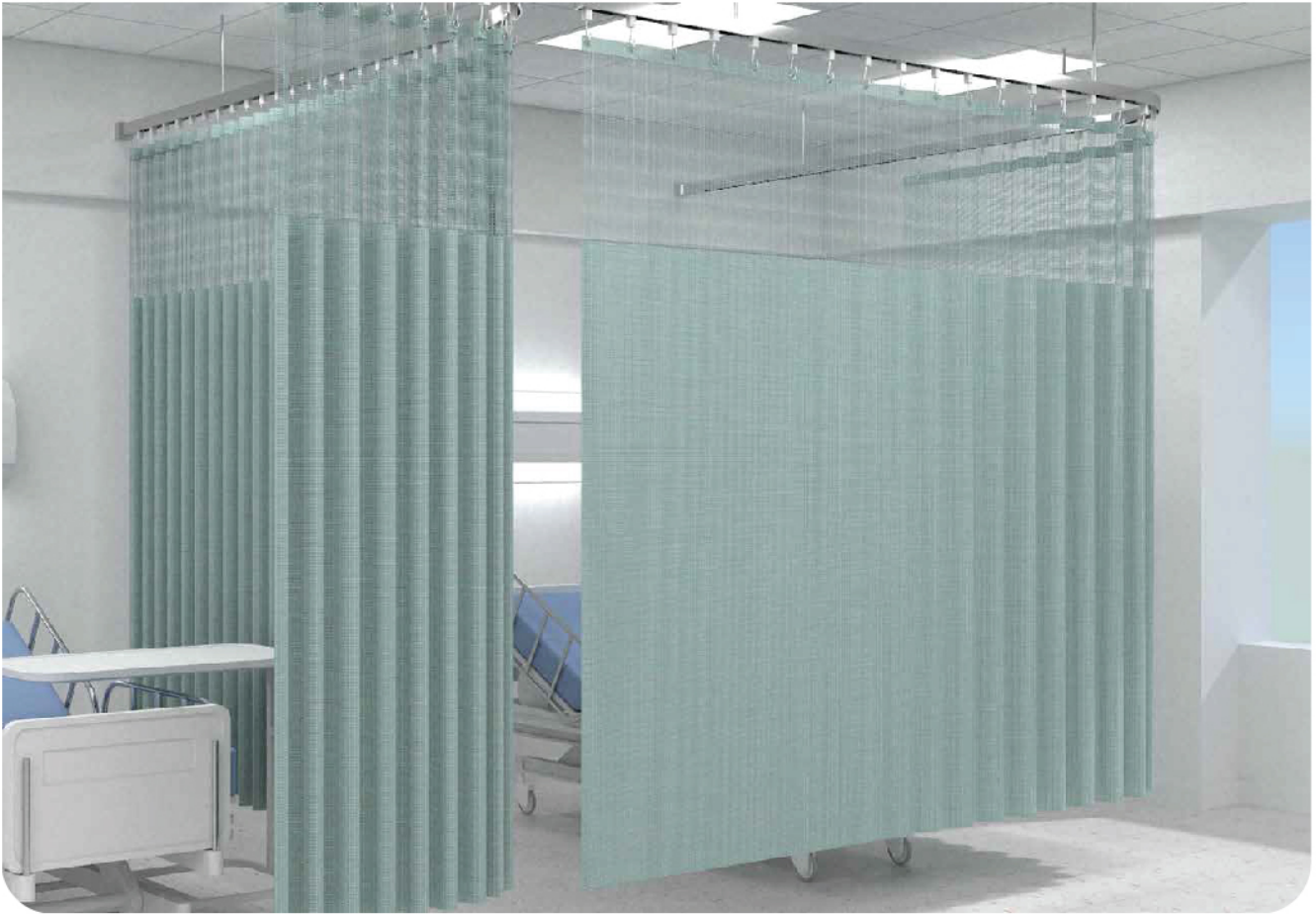

Colors

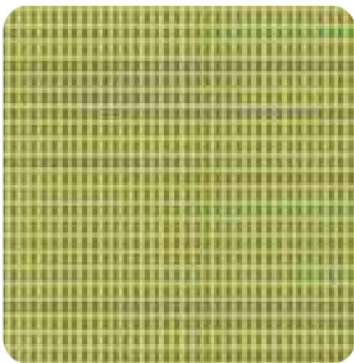

KESSLER



CONTESSA

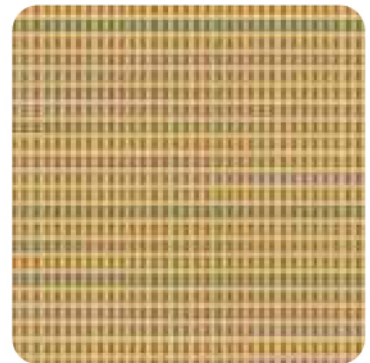

SLOAN

Description: 102" wide dual sided printed including 21" of integral mesh.

Maximum Railroaded Seamless Curtain Height: 98" including integral mesh.

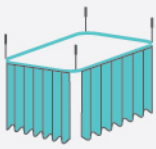

Euro Systems®

Healthcare Curtain

Track System - 4100 and Fabric

PATTERN: UNDER THE SEA



Colors



UNDER THE SEA

Description: 102" wide dual sided printed including 21" of integral mesh.

Maximum Railroaded Seamless Curtain Height: 98" including integral mesh.

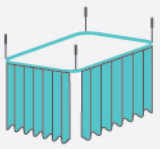

Euro Systems®

Healthcare Curtain

Track System - 4100 and Fabric

PATTERN: WAVE



Colors



CAMPO



PORTO



SPLASH

Description: 102" wide dual sided printed including 21" of integral mesh.

Maximum Railroaded Seamless Curtain Height: 98" including integral mesh.

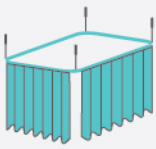

Euro Systems®

Healthcare Curtain

Track System - 4100 and Fabric

INTEGRAL MESH

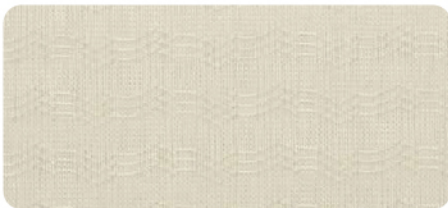

Early Dawn



Clean Khaki



Classic Gray



Shaker Beige



Light Taupe



Island Coral



Bluewater

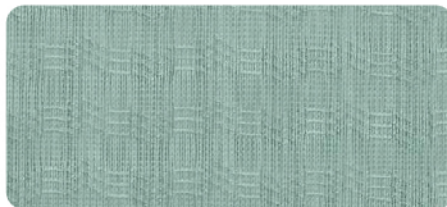

Soft Aloe



Pottery Green



Greyscale

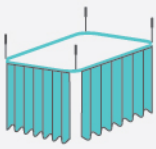

Euro Systems®

Healthcare Curtain

Track System - 4100 and Fabric

INTEGRAL MESH

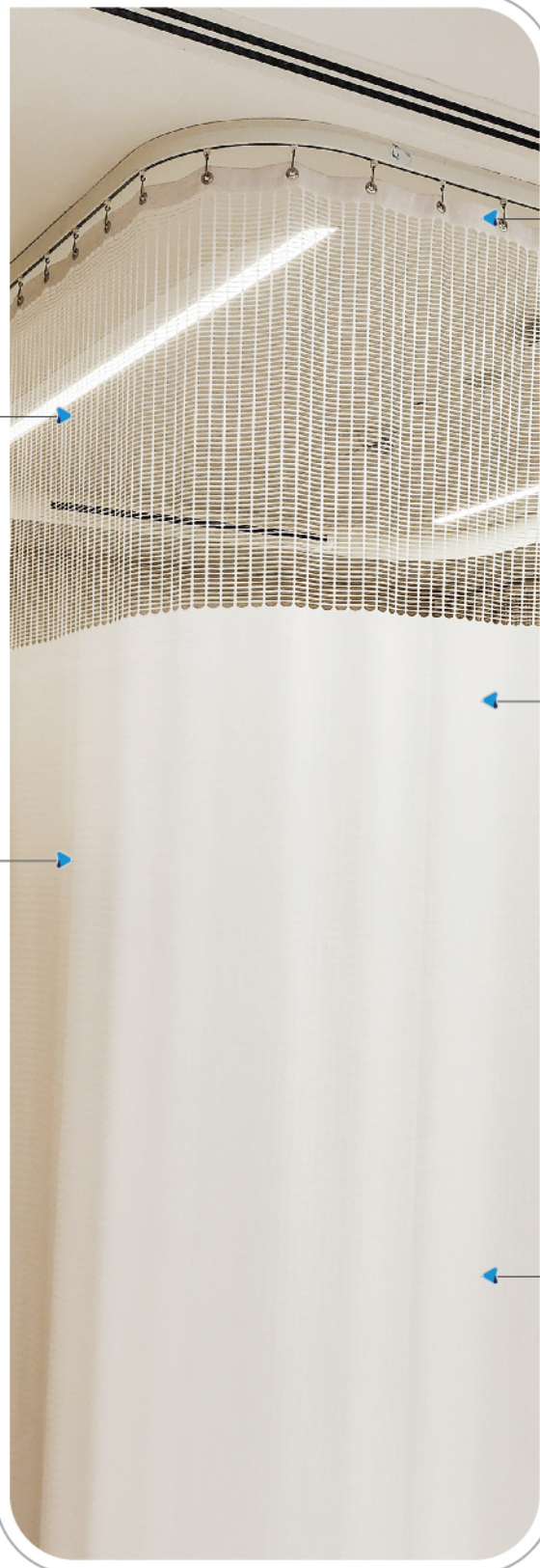

Integral mesh construction provides continuity of design with life-long code compliance.

No puckering, shrinking or weakness with our unique one piece construction.

Four inch fabric header triple folds to reinforce grommets and ensure superior strength.

Integral mesh fabric, 102" wide, requires no repeat or seaming, which translates into savings.

Integral mesh retains its shape through frequent laundering; always hangs and stacks beautifully.

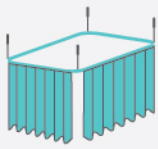

Euro Systems®

Healthcare Curtain

Track System - 4100 and Fabric

Content:

100% FR Polyester

Width:

27.2 ounces per linear yard

Flammability:

NFPA 701: Passes

NFPA 13: Passes (spinkler code opening exceed 70% requirement)

Laundry:

Machine Wash to 160°F/71° C

Tumble at 140°F/60°C

Fabric will not shrink, Pill or fade when cleaned as directed

PRINTED KAYLOR KUBE**Width:**

Overall: 102"/259cm

Header: 1" Triple fold (4"/10cm unfolded)

Integral Mesh: 20"/51cm

Body: 78"/198cm

Up to 98"/248cm length including integral mesh

Typical Curtain Length: 12"/30cm AFF

(above finished floor)

Recommended Fullness: 15%

Dimensions

Header: 1" Triple fold (4"/10cm Unfolded)

Hems: 1"/3cm triple fold with loc-stitch

Grommet: # 1 nickel-plated brass on center every 6"/15cm

Design

Integral mesh prints

Integral mesh solid colors

UNPRINTED/PIECE DYED KAYLOR KUBE**Width:**

Overall: 104"-106"/264CM-269cm

Header: 1" Triple fold (4"/10cm unfolded)

Integral Mesh: 22"/56cm

Body: 78"/198cm

Up to 100"/249cm length including integral mesh

Typical Curtain Length: 12"/30cm AFF

(above finished floor)

Recommended Fullness: 15%

Dimensions

Header: 1" Triple fold /4" Unfolded)

Hems: 1"/3cm triple fold with loc-stitch

Grommet: # 1 nickel-plated brass on center every 6"/15cm